

WDG 043DZOM

High Speed Position Counters and Differential Counters with two Encoder Inputs



- **Electronic counter series for high-end applications**
- **Two independent encoder inputs, each with channels A, /A, B, /B , 1 MHz of counting capability and individual impulse scaling facility**
- **Selectable operating modes for fast position or event counter, summing counter, differential counter, cutting length indicator, diameter calculator and more**
- **4 preset levels with high-speed power transistor outputs**
- **RS232 interface and high-speed analogue output available**
- **Choice of 6-decade display (15 mm, 0.56") or 8-decade display (10 mm, 0.36")**

Operating Instructions



Safety Instructions

- **This manual is an essential part of the unit and contains important hints about function, correct handling and commissioning. Non-observance can result in damage to the unit or the machine or even in injury to persons using the equipment!**
- **The unit must only be installed, connected and activated by a qualified electrician**
- **It is a must to observe all general and also all country-specific and application-specific safety standards**
- **When this unit is used with applications where failure or maloperation could cause damage to a machine or hazard to the operating staff, it is indispensable to meet effective precautions in order to avoid such consequences**
- **Regarding installation, wiring, environmental conditions, screening of cables and earthing, you must follow the general standards of industrial automation industry**
- **- Errors and omissions excepted -**

Table of Contents

1. Introduction.....	4
2. Electrical Connections	5
2.1. Power Supply	7
2.2. Auxiliary Outputs for Encoder Supply	7
2.3. Impulse Inputs for Incremental Encoders	7
2.4. Control Inputs Cont.1 – Cont.4	7
2.5. Switching Outputs K1 – K4	8
2.6. Serial Interface.....	8
3. Operating Modes of the Counter	9
3.1. “Single Mode” (Encoder 1 only): <u>F07.062 = 0</u>	10
3.2. “Sum Mode” (Encoder 1 + Encoder 2): <u>F07.062 = 1</u>	11
3.3. Differential Mode (Encoder 1 – Encoder 2): <u>F07.062 = 2</u>	12
3.4. Master Counter and Integrated Batch Counter: <u>F07.062 = 3</u>	13
3.5. Evaluation of the Real Cutting Length: <u>F07.062 = 4</u>	14
3.6. Diameter Calculation with Winding Rolls: <u>F07.062 = 5</u>	15
3.7. Radius Calculation with Winding Rolls: <u>F07.062 = 6</u>	16
3.8. Monitor for Slip, Torsion, Skew Position, Shaft Fracture: <u>F07.062 = 9</u>	17
3.9. Dual Counter, Two Independent Counters for Encoders 1 and 2: <u>F07.062 = 10</u>	18
4. Keypad Operation	19
4.1. Normal Operation.....	19
4.2. General Setup Procedure.....	19
4.3. Direct Fast Access to Presets	20
4.4. Change of Parameter Values on the Numeric Level	21
4.5. Code Protection against Unauthorized Keypad Access.....	22
4.6. Return from the Programming Levels and Time-Out Function	22
4.7. Reset all Parameters to Factory Default Values.....	22
5. Menu Structure and Description of Parameters.....	23
5.1. Summary of the Menu.....	23
5.2. Description of the Parameters.....	26
5.3. Clarification of the Counter Setting Functions.....	35
6. Specifications	37
7. Dimensions	38
8. Appendix: Serial Communication Details.....	39
8.1. Setup of the Counter by PC	39
8.2. Automatic and Cyclic Data Transmission	40
8.3. Communication Protocol	40
8.4. Serial Register Codes	42

1. Introduction

The counters of this series have been designed to close a gap with multiple counting applications, which cannot be accomplished by the normal industrial electronic counters available on the market.

A continual demand for increasing production speeds and higher precision at the same time results in counting frequencies exceeding the conventional frequency range.

Particularly with fast running procedures it is most important to also have fast response of the switching outputs or the analogue output.

Many applications require to evaluate the signals of two incremental measuring systems, and to compare the results with respect to the sum or the difference or the ratio of the two positions. This is e.g. necessary for calculation of diameters of winding rolls etc.

These are some of the reasons why this new counter series have been designed.



- **This manual at first provides all basic instructions for operation of the counter models presented in the previous chapter**
- **For easy PC setup and communication with the counters, you can optionally use the “OS32” operator software. Where you like to have free serial access to the unit by PLC or IPC or by a remote operator terminal, please observe the serial protocol details described in our separate manual “Serpro”**

2. Electrical Connections

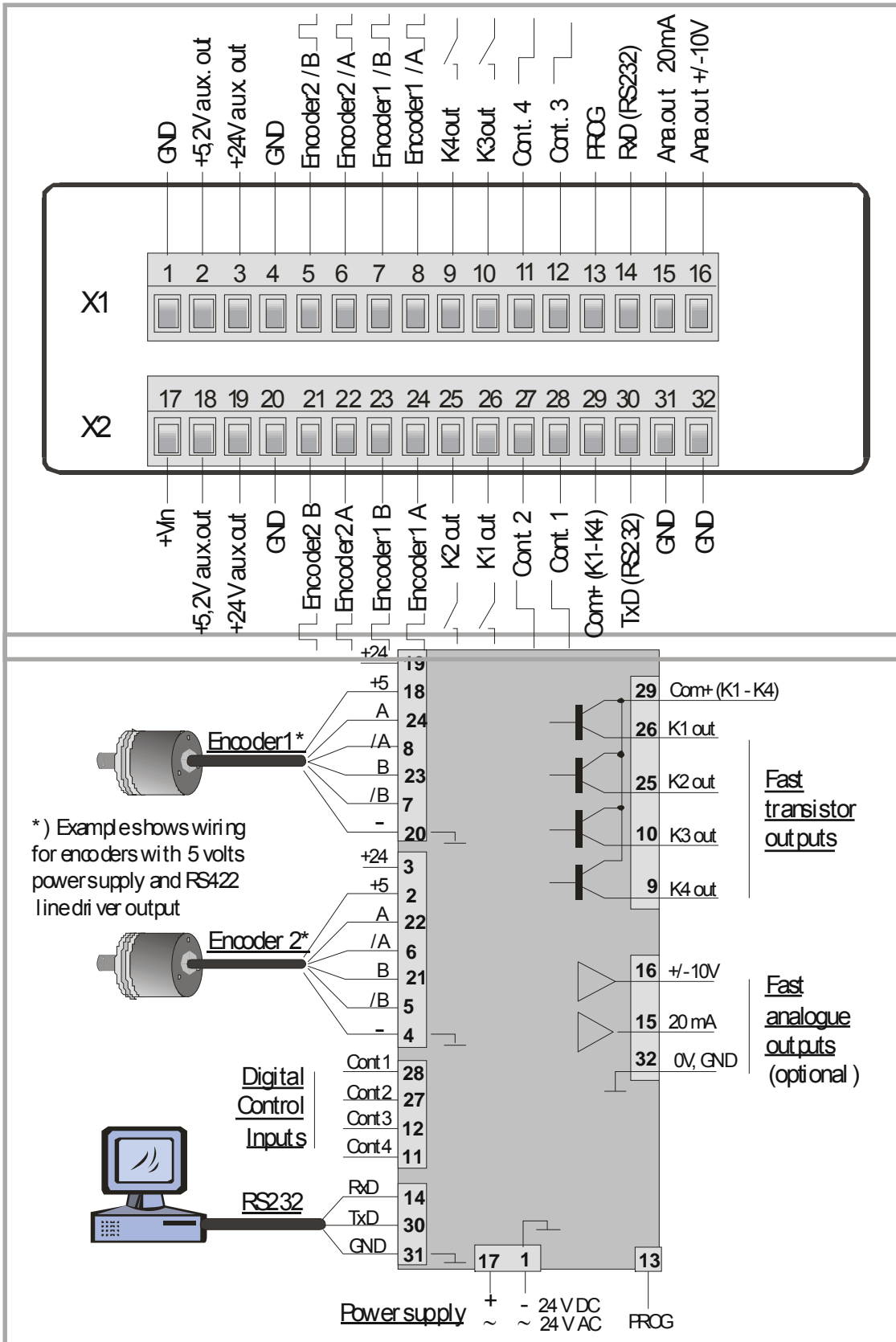

Terminal	Name	Function
01	GND	Common Ground Potential (0V)
02	+5,2V out	Aux. output 5.2V/150 mA for encoder supply
03	+24V out	Aux. output 24V/120 mA for encoder supply
04	GND	Common Ground Potential (0V)
05	Encoder 2, /B	Encoder 2, channel /B (B inverted)
06	Encoder 2, /A	Encoder 2, channel /A (A inverted)
07	Encoder 1, /B	Encoder 1, channel /B (B inverted)
08	Encoder 1, /A	Encoder 1, channel /A (A inverted)
09	K4 out	Output K4, transistor PNP 30 volts, 350 mA
10	K3 out	Output K3, transistor PNP 30 volts, 350 mA
11	Cont.4	Digital control input
12	Cont.3	Digital control input
13	(PROG)	(for download of new firmware only, not for general use)
14	RxD	Serial RS232 interface, input (Receive Data)
17	+Vin	Power supply input, +17 - 40 VDC or 24 VAC
18	+5,2V out	Aux. output 5,2V/150 mA for encoder supply
19	+24V out	Aux. output 24V/120 mA for encoder supply
20	GND	Common Ground Potential (0V)
21	Encoder 2, B	Encoder 2, channel B (non-inverted)
22	Encoder 2, A	Encoder 2, channel A (non-inverted)
23	Encoder 1, B	Encoder 1, channel B (non-inverted)
24	Encoder 1, A	Encoder 1, channel A (non-inverted)
25	K2 out	Output K2, transistor PNP 30 volts, 350 mA
26	K1 out	Output K1, transistor PNP 30 volts, 350 mA
27	Cont.2	Digital control input
28	Cont.1	Digital control input
29	Com+ (K1-K4)	Common positive input for transistor outputs K1-K4
30	TxD	Serial RS232 interface, output (Transmit Data)
31	GND	Common Ground Potential (0V)

*) 120 mA and 150 mA are per encoder, i.e. total maximum currents are 240 mA and 300 mA

2.1. Power Supply

The counters accepts both, a 17 – 40 volts DC power or a 24 volts AC power for supply via terminals 17 and 1. The current consumption depends on the level of the input voltage and some internal conditions; therefore it can vary in a range from 100 – 200 mA (aux. currents taken from the unit for encoder supply not included).

2.2. Auxiliary Outputs for Encoder Supply

Terminals 2 and 18 provide an auxiliary output with approx. +5.2 volts DC (300 mA totally). Terminals 3 and 19 provide an auxiliary output with approx. +24 volts DC (240 mA totally)

2.3. Impulse Inputs for Incremental Encoders

All input characteristics of the impulse inputs can be set by the parameter menu, for each of the encoders separately. Depending on the application the unit can accept single channel information (input A only) or quadrature information (A / B, 90°). The following settings are possible:

- Symmetric input (differential) according to RS422 standard
- TTL inputs at a level of 3.0 to 5 volts (differential, with inverted signal)
- TTL inputs at a level of 3.0 to 5 volts (single-ended) *)
- HTL signals at a 10 – 30 volts level
(alternatively differential with inverted signals A, /A, B, /B, or single-ended A, B only)
- Impulses from photocells or proximity switches etc. providing a HTL level (10 – 30 volts)
- Proximity switches according to NAMUR (2-wire) standard
(may need additional remote resistor)

*) requires special settings of the threshold parameters, see “Special parameters F04”

2.4. Control Inputs Cont.1 – Cont.4

These inputs can be configured for various remote functions like Reset, Set, Latch, and Inhibit or switch-over purpose.

All control inputs require HTL level. They can be individually set to either NPN (switch to -) or PNP (switch to +) characteristics. For applications where edge-triggered action is needed, the menu allows to set the active edge (rising or falling). Control inputs also accept signals with Namur (2-wire) standard. For reliable operation the minimum pulse width on the control inputs should be 50 µsec.

2.5. Switching Outputs K1 – K4

The units provide four presets and outputs with programmable switching characteristics.

K1 – K4 are fast-switching and short-circuit-proof transistor outputs with a switching capability of 5 – 30 volts / 350 mA each. The switching voltage of the outputs must be applied remotely to the Com+ input (terminal 29)

2.6. Serial Interface

The serial RS232 interface can be used for the following purposes:

- Set-up of the unit by PC (if desirable), by means of the OS32 PC software
- Change of parameters during operation
- Readout of actual counter or other values by PLC or PC

The figure below explains the connection between a counter and a PC using the standard Sub-D-9 serial connector

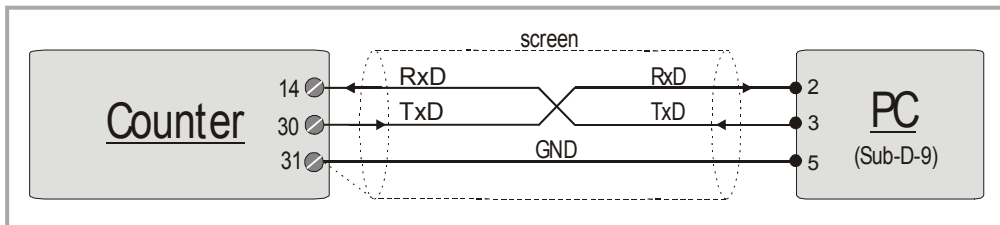

For details of serial communication, please refer to section 10.

3. Operating Modes of the Counter

For best survey, all parameters of the unit are arranged in 13 expedient groups, named "F01" - "F13". Depending on the application, only a few of these groups may be important, while all other groups may be irrelevant for your specific application.

This section describes possible applications and operating modes of the counter. The operation mode can be set under parameter group F07, parameter # F07.062.

The following counting functions are available:

Operating Mode F07.062	Counter Function
0	Single counter mode, encoder 1 only
1	Summing counter mode (encoder 1 + encoder 2)
2	Differential counter mode (encoder 1 - encoder 2)
3	Master counter and batch counter
4	Display of the actual cutting length with cutting "on the fly" applications
5	Roll diameter calculation with winding rolls
6	Roll radius calculation with winding rolls
7	n.a.
8	n.a.
9	Control of slip, torsion, skew position, shaft fracture etc.
10	Dual counter, two independent counters for encoder 1 and encoder 2



- It is possible to cycle the display between the five reading modes shown in the following function tables, by pressing one of the front keys or by using one of the control inputs (you must have assigned the display scroll function to one of the keys or the inputs under menu F06, to activate the scrolling of the display). LEDs L1 and L2 indicate which of the values is actually displayed.
- Scrolling of the display from one reading mode to another will not affect the function of the preselection outputs K1 - K4
- The analogue output (models --AZOM) can be assigned to any of the readings accessible in the display, by a special parameter. Scrolling of the display from one reading mode to another will not affect the analogue output.
- As far as the selected counter mode also allows reading out the minimum and maximum values or the positions of the last change of direction, please note that the unit latches these extreme values in time periods of 1 msec. only. Therefore the display of memorized extreme positions may include some inaccuracy with high counting frequencies (real extreme value may lie between two records)

Full details about parameter arrangement and function can be found under section 6.



All operating modes provide separate impulse scaling factors for each of the two encoders. Please observe that the display of the counter will only show whole numbers (integers) whereas remainders will be carried in the background

Example: Differential Counter:

Encoder1		Impulse Scaling Factor1		Encoder2		Impulse Scaling Factor2		Display	Remainder (background)
1000 Impulses	x	0,98765	minus	2000 Impulses	x	1,23456			
967,65000			-	2469,12000			=	-1501	0,47000

3.1. "Single Mode" (Encoder 1 only): F07.062 = 0

Only the inputs of encoder 1 are active, signals on the encoder 2 inputs will not be evaluated. Besides the actual counter value, the unit also records minimum and maximum values as well as the last positions of change of direction.

All 4 presets are related to the actual counter value.

	Display	L1 (red)	L2 (yellow)
1	Actual counter value	--	--
2	Minimum value since last reset	blinking fast	--
3	Maximum value since last reset	--	blinking fast
4	Position of last change of direction (up and low)	blinking slow	--
5	Only lower point of change of direction (F04.030 = 0) Only upper point of change of direction (F04.030 = 1)	--	blinking slow

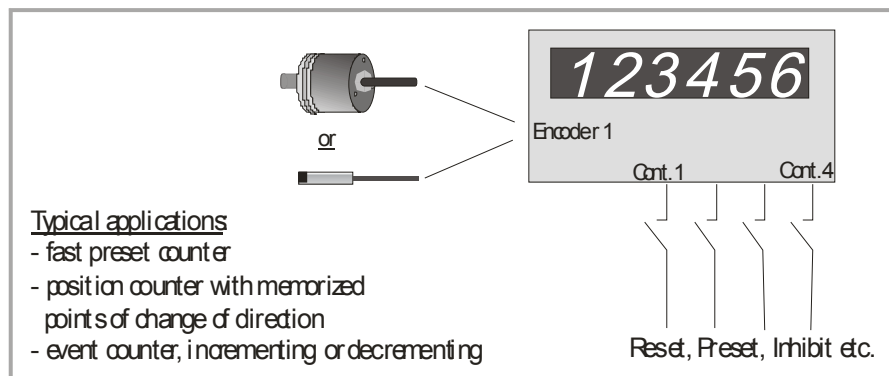

3.2. "Sum Mode" (Encoder 1 + Encoder 2): F07.062 = 1

Both inputs encoder 1 and encoder 2 are active. From both values the unit forms the sum, with consideration of the individual encoder scaling factors. Where the encoder signal also provides direction information, this information will be considered by a corresponding sign of the count. Without direction information (channel A only) both encoder values will be added up. The final result can once more be scaled into user-friendly engineering units by means of the special scaling parameters in parameter group F07.

Besides the actual counter value and the sum, the unit also records minimum and maximum values of the sum.

Presets K1 and K2 are related to the actual counter value of encoder 1 only.

Presets K3 and K4 are related to the actual sum result (encoder 1 + encoder 2)

	Display	L1 (red)	L2 (yellow)
1	Actual sum encoder 1 + encoder 2	--	--
2	Minimum value of the sum (since last reset)	blinking fast	--
3	Maximum value of the sum (since last reset)	--	blinking fast
4	Actual counter value of encoder 1 alone	blinking slow	--
5	Actual counter value of encoder 2 alone	--	blinking slow

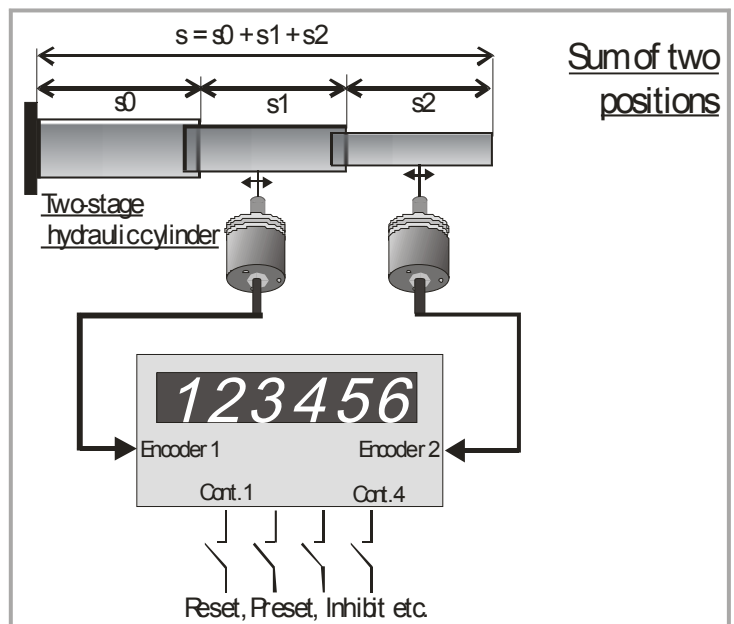
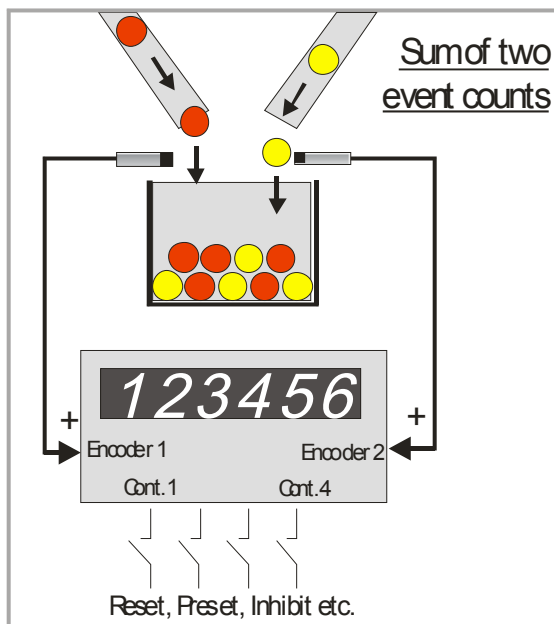

3.3. Differential Mode (Encoder 1 – Encoder 2): F07.062 = 2

Both inputs encoder 1 and encoder 2 are active. From both values the unit forms the difference, with consideration of the individual encoder scaling factors.

Where the encoder signal also provides direction information, this information will be considered by a corresponding sign of the count. Without direction information (channel A only) encoder 1 will increment and encoder 2 will decrement the counter. The final result can once more be scaled into user-friendly engineering units by means of the special scaling parameters in parameter group F07.

Besides the actual counter value and the difference, the unit also records minimum and maximum values of the difference.

Presets K1 and K2 are related to the actual counter value of encoder 1 only.

Presets K3 and K4 are related to the actual differential result (encoder 1 - encoder 2)

	Display	L1 (red)	L2 (yellow)
1	Actual difference encoder 1 - encoder 2	--	--
2	Minimum value of the difference (since last reset)	blinking fast	--
3	Maximum value of the difference (since last reset)	--	blinking fast
4	Actual counter value of encoder 1 alone	blinking slow	--
5	Actual counter value of encoder 2 alone	--	blinking slow

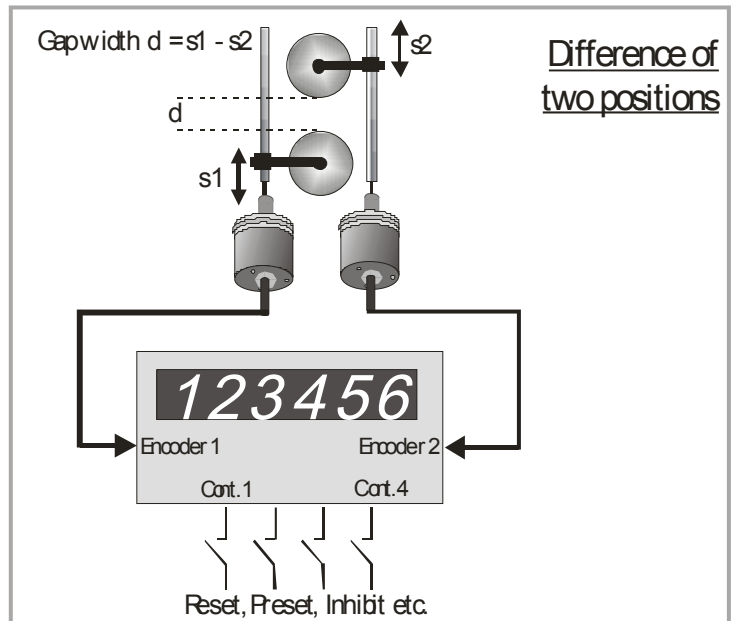
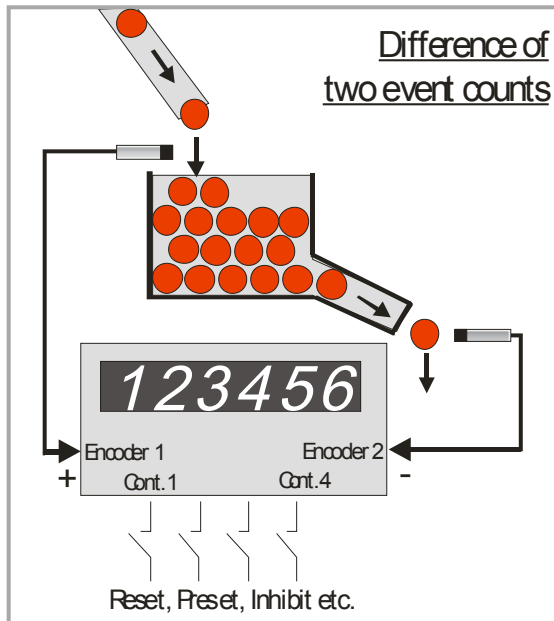

3.4. Master Counter and Integrated Batch Counter: F07.062 = 3

This counter mode can be used for cut-to lengths applications, cyclic production flows, packing procedures etc. While the master counter takes care of the correct number of impulses per product, the background batch counter counts the number of products produced.

This mode assumes that the automatic reset function has been activated for the master counter, providing restart from zero every time the preset value has been reached. *)

Only the inputs of encoder 1 are active (master counter).

Every time the master counter reaches its preset value, it restarts from zero and the batch counter increments by 1. ***)

The batch counter can be decremented by separate external signal, when one of the keys or control inputs has been defined correspondingly. **)

Besides the master counter and the batch counter, the unit also records minimum and maximum values of the batch count.

Presets K1 and K2 are related to the actual counter value of encoder 1.

Presets K3 and K4 are related to the actual value of the batch counter.

	Display	L1 (red)	L2 (yellow)
1	Actual counter value of batch counter	--	--
2	Minimum value of batch counter (since last reset)	blinking fast	--
3	Maximum value of batch counter (since last reset)	--	blinking fast
4	Actual counter value of master counter (encoder 1)	blinking slow	--
5	Actual counter value of batch counter	--	blinking slow

*) Example: If 500 impulses on encoder 1 are necessary for 1 product:

- a. Set F01.000 to 500 (preset level 1)
- b. Set F10.089 = 1.00 sec. (output pulse time K1)
- c. Set F10.097 = 2 or 4 (automatic restart from 0)

**) Select parameter group F06 and assign the special command "13" to any of the keys or control inputs for remote decrementing of the batch counter

***) As a matter of course the counting sense can also be reversed, i.e. the main counter loads a preset value, counts down towards zero, increments the batch counter when reaching zero and sets to the preset value again

3.5. Evaluation of the Real Cutting Length: F07.062 = 4

This mode uses encoder 1 as a length counter and encoder 2 is not active. All counting occurs in the background and is not visible in the display. The counter gets started and stopped by remote control signals, and the final counting result appears in the display (frozen) whilst the counter already executes the next cycle in the background.

For remote start and stop signals the inputs Cont.1 and Cont.2 must be used, therefore these inputs are no more available for other purpose. All assignments of the signals and the active edges (rising or falling) can individually be set to match with the actual measuring situation.

Examples:

- use the rising edge of the Cont1 input to latch and reset, This will display your cutting length as shown in the picture below.
- Use Cont1 to start the measuring cycle and Cont2 to stop and latch. This will display the differential length between the two remote signals
- Use the same signal in parallel to Cont1 and Cont2. This e.g. allows to measure a gap or distance between two products, while the remote signal is high (or low)

This mode is useful to get information about the actual cutting length with applications like Rotary Cutters, Flying Shears and similar procedures. The automatic reset function is automatically on in order to ensure that the next measuring cycle will restart at zero.

Besides the actual cutting length the unit also records the extreme length values (minimum and maximum) of all cuts.

Presets K1 and K2 are related to the actual counter value of encoder 1 (live background counter). Presets K3 and K4 are related to the real cutting lengths shown in the frozen display. Therefore K3 and K4 can be used for quality sorting purpose (e.g. too short – good – too long)

	Display	L1 (red)	L2 (yellow)
1	Last actual cutting length (frozen)	--	--
2	Minimum length (since last reset)	blinking fast	--
3	Maximum length (since last reset)	--	blinking fast
4	Actual background counter (live)	blinking slow	--
5	Last actual cutting length (frozen)	--	blinking slow

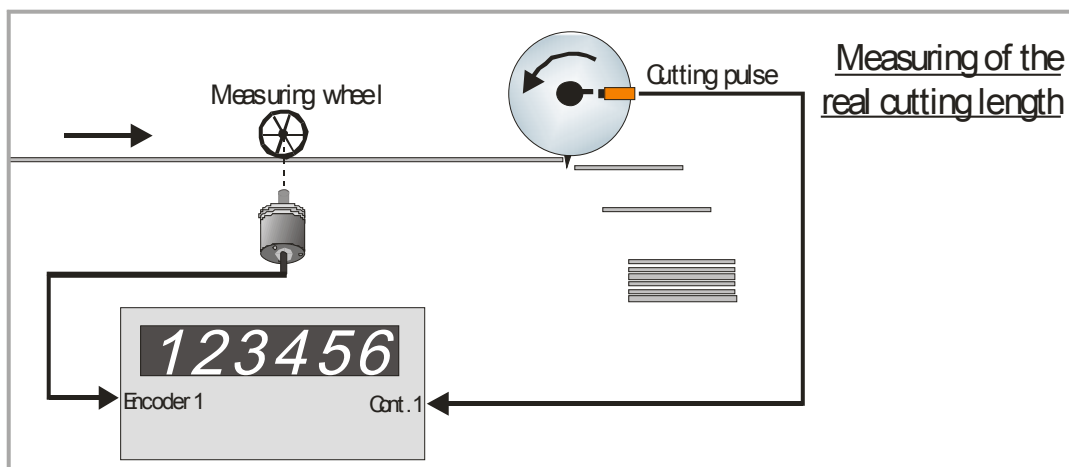

3.6. Diameter Calculation with Winding Rolls: F07.062 = 5

With this mode encoder 1 receives line impulses from a measuring wheel or a feed roll of a winder or unwinder application. Furthermore the counter needs one trigger impulse from the rotation of the winding roll. From both signals the counter can calculate and display the actual roll diameter. All counting occurs in the background and only updated diameter readings appear in the display. Encoder 2 is not in use with this application.

The scaling parameters F07.066 and F07.067 are automatically set to the appropriate values with this application. Parameter F07.068 allows setting a core diameter.

When set to zero, the display will show the full roll diameter.

When set to a core diameter, the display will show the remaining material diameter (full diameter - core diameter).

Besides the total material length and the actual diameter the unit also records the extreme diameter values (minimum and maximum) coming up during the process.

Presets K1 and K2 are related to the actual line counter of encoder 1 (total material length under the measuring roll).

Presets K3 and K4 are related to the actual diameter value of the winding roll.

	Display	L1 (red)	L2 (yellow)
1	Actual roll diameter	--	--
2	Minimum diameter (since last reset)	blinking fast	--
3	Maximum diameter (since last reset)	--	blinking fast
4	Actual value of the line counter	blinking slow	--
5	Last counting result of the line counter	--	blinking slow

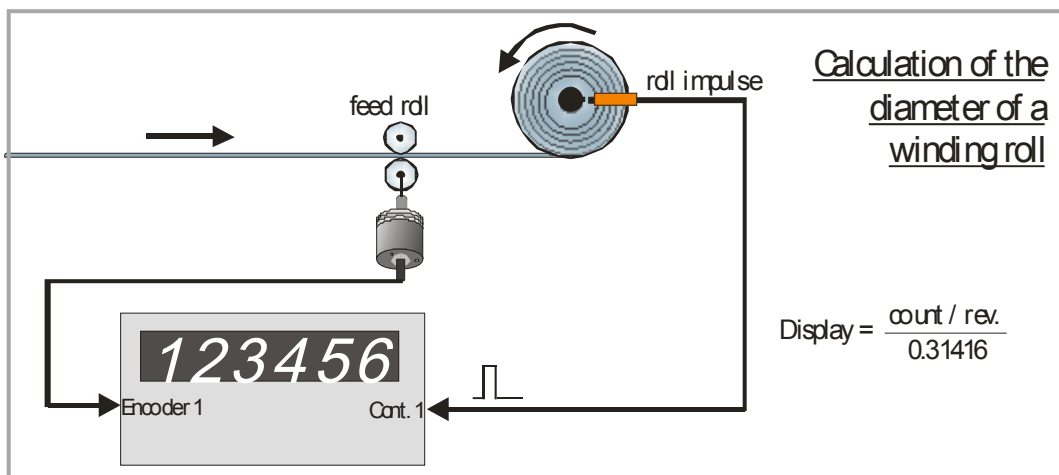

3.7. Radius Calculation with Winding Rolls: F07.062 = 6

With this mode encoder 1 receives line impulses from a measuring wheel or a feed roll of a winder or unwinder application. Furthermore the counter needs one trigger impulse from the rotation of the winding roll. From both signals the counter can calculate and display the actual radius of the roll. All counting occurs in the background and only updated diameter readings appear in the display. Encoder 2 is not in use with this application.

The scaling parameters F07.066 and F07.067 are automatically set to the appropriate values with this application. Parameter F07.068 allows setting a core radius.

When set to zero, the display will show the full radius of the roll.

When set to a core radius, the display will show the remaining radius of the material (full radius - core radius).

Besides the total material length and the actual radius the unit also records the extreme radius values (minimum and maximum) coming up during the process.

Presets K1 and K2 are related to the actual line counter of encoder 1 (total material length under the measuring roll).

Presets K3 and K4 are related to the actual radius value of the winding roll.

	Display	L1 (red)	L2 (yellow)
1	Actual roll radius	--	--
2	Minimum radius (since last reset)	blinking fast	--
3	Maximum radius (since last reset)	--	blinking fast
4	Actual value of the line counter	blinking slow	--
5	Last counting result of the line counter	--	blinking slow

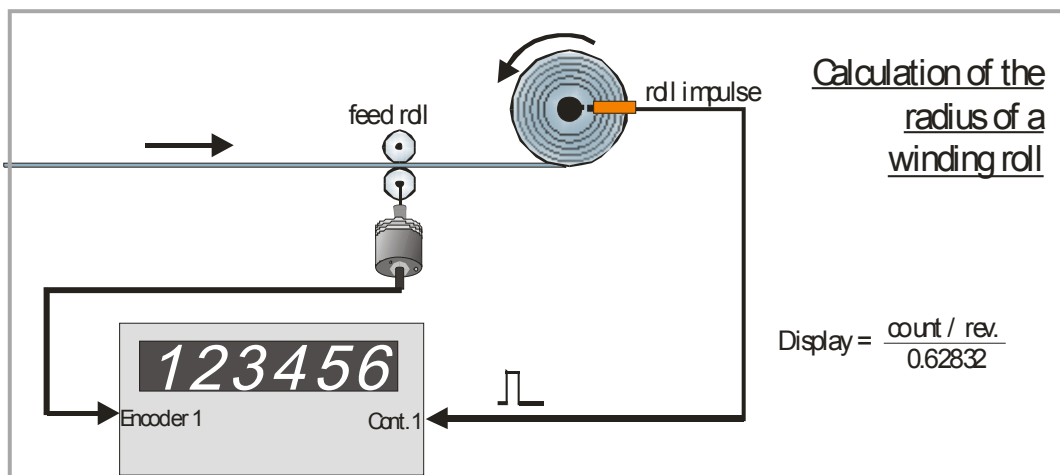

3.8. Monitor for Slip, Torsion, Skew Position, Shaft Fracture: F07.062 = 9

This counter mode is a special version of the Differential Counter described previously. As a major difference, in this mode all four presets and outputs (K1 – K4) refer exclusively to the differential count, and also a programmable slip function has been added.

Before forming the difference, each of the two encoder inputs is scaled individually according to the setting of the impulse scaling factor. If applicable, the differential result can once more be scaled to engineering units with use of the final scaling operands.

Since presets and outputs can be set to positive and negative values as well, it is also possible to use the unit for simple synchronous control purpose of two drives, by temporary accelerating or breaking one of the drives when lagging or leading the other. Typical examples are large rolling gates or lifting ramps or gantry cranes, driven by several independent motors.

Some applications (e.g. with couplings) can accept (or even may require) a certain slip. For slip control with adjustable slip parameters, an automatic timer function can be programmed to reset the counters periodically.

Multi-purpose parameter F04.030 is used to set the reset cycle in seconds (00.0 = no automatic reset, 99.9 = reset every 99.9 seconds)

Since with slip applications, where the automatic reset function is switched on, the real time display of the counter may be very confusing, multi-purpose parameter F04.031 works to reduce the update rate of the display

(0 = real-time display, 1 = 8 msec., 2 = 16 msec., 3 = 32 msec., 4 = 64 msec. etc.)

Besides the differential count, the display can be scrolled to indicate also the following values:

	Display	L1 (red)	L2 (yellow)
1	Differential count (encoder1 – encoder2)	--	--
2	Minimum difference (since last reset)	blinking fast	--
3	Maximum difference (since last reset)	--	blinking fast
4	Encoder 1 only	blinking slow	--
5	Encoder 2 only	--	blinking slow

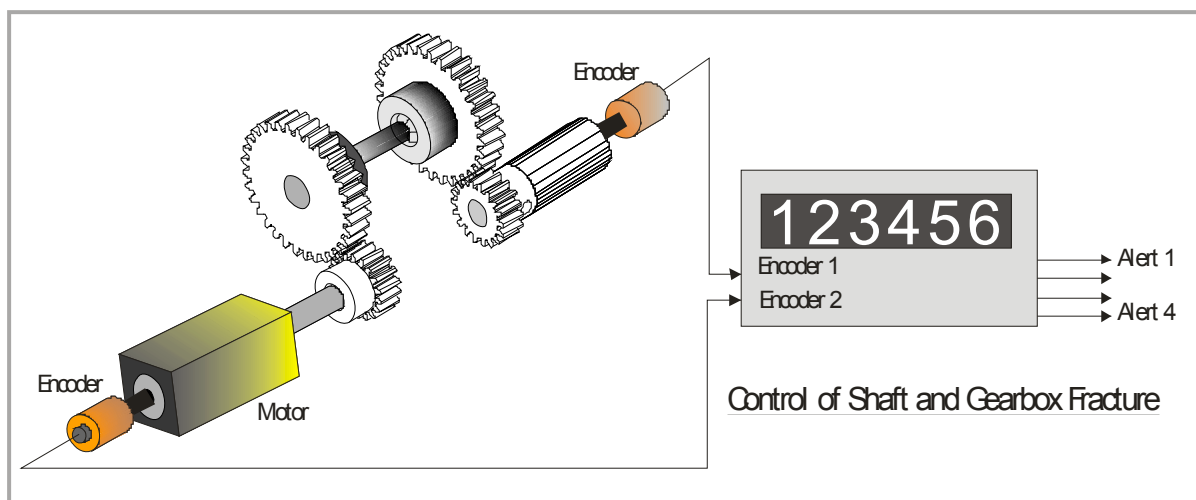

3.9. Dual Counter, Two Independent Counters for Encoders 1 and 2: F07.062 = 10

Both encoder inputs operate fully independent one from the other, with individual scaling, evaluation and display. Also each counter can be set or reset individually.

Both counters are treated equally, except with recording of minimum and maximum values. With regard to this function one of the two counters has to be declared as the "main counter".

The unit will record the min/max values of the main counter only and no min/max values will be available of the other counter.

Attribution of the main counter uses the Multi-Purpose Parameter 1 (F04.030)

F04.030 = 0 : Encoder 1 represents the main counter (default)

F04.030 = 1 : Encoder 2 represents the main counter

Presets K1 and K2 are always related to the main counter.

Presets K3 and K4 refer to the other of the two counters

With many applications it may be desirable to toggle the display only between encoder 1 and encoder 2, without needing to pass over all the other values every time. Therefore the Multi-Purpose Parameter 2 (F04.031) can be used to choose between one of the following two display sequences:

F04.031 = 0 : Standard display sequence with all display values* (default)

	Display	L1 (red)	L2 (yellow)
1	Main counter (encoder 1 or encoder 2)	--	--
2	Minimum value of main counter (since last reset)	blinking fast	--
3	Maximum value of main counter (since last reset)	--	blinking fast
4	Counter of encoder 1	blinking slow	--
5	Counter of encoder 2	--	blinking slow

F04.031 = 1 : Short display sequence to toggle between encoders 1 and 2 only

	Display	L1 (red)	L2 (yellow)
1	Counter of encoder 1	blinking slow	--
2	Counter of encoder 2	--	blinking slow







***) Units with analogue output will always generate the analogue signal from one of the lines 1 to 5, according to assignment by parameter F08.079. This is also valid when the short display sequence is used.**

4. Keypad Operation

An overview of all parameters and explanations can be found under section 6.

The menu of the unit uses four keys, hereinafter named as follows:

			
PROG	UP	DOWN	ENTER

Key functions depend on the actual operating state of the unit. Essentially we have to describe three basic states:

- **Normal operation**
- **General setup procedure**
- **Direct fast access to presets and set values**

4.1. Normal Operation











In this mode the unit operates as a counter according to the settings defined upon setup. All front keys may have customer-defined functions according to the specifications met in the keypad definition menu F06 (e.g. scrolling of the display, Reset, Inhibit etc.)

4.2. General Setup Procedure

The unit changes over from normal operation to setup level when keeping the  key down for at least 2 seconds. Thereafter you can select one of the parameter groups F01 to F13.

Inside the group you can now select the desired parameter and set the value according to need. After this you can either set more parameters or return to the normal operation.

The adjoining sequence of key operations explains how to change **Parameter number 052 of group F06 from the original value of 0 to 8**

Step	State	Key action	Display	Comment	
00	Normal operation		Counting		
01		 > 2 sec.	F01	Display of the Parameter group	
02	Level: Parameter group	 5 x	F02 ... F06	Select group # F06	
03			F06.050	Confirmation of F06. The first parameter of this group is F06.050	
04	Level: Parameter numbers	 2 x	F06.051... F06.052	Select parameter 052	
05			0	Parameter 052 appears in display, actual setting is 0	
06	Level: Parameter values	 8 x	1 8	Setting has been modified from 0 to 8	
07			F06.052	Save the new setting (8)	
08	Level: Parameter numbers		F06	Return to level parameter groups	
09	Level: Parameter groups		Counting	Return to normal operation	
10	Normal operation				
			During the general setup procedure all counter activities remain disabled. New parameter settings become active after return to normal operation only.		

4.3. Direct Fast Access to Presets

To get to the fast access routine, please press both





 and  at the same time

This will access the parameter group F01 right away. To change of the settings follow the same procedure as already described above. Besides the advantage of direct access, the fundamental difference to general setup is the following:

	<p>During the fast access procedure all counter functions remain fully active. Access is limited to presets; no other parameters can be changed.</p>
---	---

4.4. Change of Parameter Values on the Numeric Level











The numeric range of the parameters is up to 6 digits with 6-decade models and up to 8 digits with 8 decade models. Some of the parameters may also include a sign. For fast and easy setting or these values the menu uses an algorithm as shown subsequently. During this operation the front keys have the following functions:

			
PROG	UP	DOWN	ENTER
Saves the actual value shown in the display and returns to the parameter selection level	Increments the highlighted (blinking) digit	Decrements the highlighted (blinking) digit	Shifts the cursor (blinking digit) one position to the left, or from utmost left to right

With signed parameters the left digit scrolls from **0** to **9** and then shows “-„ (negative) and “-1“ (minus one). The example below shows how to change a parameter from the setting 1024 to the new setting 250 000 (using a 6 decade model).

This example assumes that you have already selected the parameter group and the parameter number, and that you actually read the parameter value in the display.

Highlighted digits appear on colored background.

Step	Display	Key action	Comment
00	001024		Display of actual parameter setting, last digit is highlighted
01		 4 x	Scroll last digit down to 0
02	001020		Shift cursor to left
03	001020	 2 x	Scroll highlighted digit down to 0
04	001000	 2 x	Shift cursor 2 positions left
05	001000		Scroll highlighted digit down to 0
06	000000		Shift cursor left
07	000000	 5 x	Scroll highlighted digit up to 5
08	050000		Shift cursor left
09	050000	 2 x	Scroll highlighted digit up to 2
10	250000		Save new setting and return to the parameter number level

4.5. Code Protection against Unauthorized Keypad Access

Parameter group F05 allows to define an own locking code for each of the parameter menus. This permits to limit access to certain parameter groups to specific persons only.

When accessing a protected parameter group, the display will first show “CODE” and wait for your entry. To continue keypad operations you must now enter the code which you have stored before, otherwise the unit will return to normal operation again.

After entering your code, press the ENTER key and keep it down until the unit responds. When your code was correct, the response will be “YES” and the menu will work normally. With incorrect code the response will be “NO” and the menu remains locked.

4.6. Return from the Programming Levels and Time-Out Function



At any time the PROG key sets the menu one level up and finally returns to normal operation. The same step occurs automatically via the time-out function, when during a period of 10 seconds no key has been touched.

Termination of the menu by automatic time-out will not store new settings, unless they have already been stored by the PROG key after editing.

4.7. Reset all Parameters to Factory Default Values

Upon special need it may be desirable to set all parameters back to their original factory settings (e.g. because you have forgotten your access code, or by too many change of settings you have achieved a complex parameter state). Default values are indicated in the parameter tables shown later.

To reset the unit to default, please take the following steps:

- **Switch power off**
- Press  and  simultaneously
- **Switch power on while you keep down both keys**



Where you decide to take this action, please note that all parameters and settings will be lost, and that you will need to run a new setup procedure again.

5. Menu Structure and Description of Parameters

All parameters are arranged in a reasonable order of functional groups (F01 to F13)
 You must only set those parameters which are really relevant for your specific application.
 Unused parameters can remain as they actually are.

5.1. Summary of the Menu

This section shows a summary of the parameter groups, with an assignment to the functional parts of the unit.

Group	Function	Group	Function
F01	Preselection values	F02	Definitions for encoder 1
000	Preselection K1	010	Encoder properties
001	Preselection K2	011	Edge count select x1, x2, x4
002	Preselection K3	012	Counting direction up/down
003	Preselection K4	013	Impulse scaling Factor
004	Preset value encoder 1	014	Multiple count factor
005	Preset value encoder 2	015	Round-loop cycle definition
F03	Definitions for encoder 2	F04	Special functions
018	Encoder properties	026	Digital input filters
019	Edge count select x1, x2, x4	027	Power down memory
020	Counting direction up/down	028	Input threshold 1
021	Impulse scaling Factor	029	Input threshold 2
022	Multiple count factor	030	Multi-purpose parameter (1)
023	Round-loop cycle definition	031	Multi-purpose parameter (2)
F05	Keypad protection codes	F06	Key commands and control inputs
033	F01	050	Key UP
034	F02	051	Key DOWN
035	F03	052	Key ENTER
036	F04	053	Input Cont.1, switching characteristics
037	F05	054	Input Cont.1, assignment of function
038	F06	055	Input Cont.2, switching characteristics
039	F07	056	Input Cont.2, assignment of function
040	F08	057	Input Cont.3, switching characteristics
041	F09	058	Input Cont.3, assignment of function
042	F10	059	Input Cont.4, switching characteristics
043	F11	060	Input Cont.4, assignment of function
044	F12		
045	F13		

Group	Function
F07	Basic settings
062	Mode of operation
063	Decimal point encoder 1
064	Decimal point encoder 2
065	Decimal point combined <1,2>
066	Multiplication factor <1,2>
067	Division factor <1,2>
068	Display offset <1,2>
069	Brightness of LED display %
F09	Serial communication
081	Serial device address
082	Baud rate
083	Data format
084	Serial protocol selection
085	Timer for auto-transmission
086	Serial code for transmission

Group	Function
F08	Not used
F10	Switching features and presets
089	K1 (static or pulse)
090	K2 (static or pulse)
091	K3 (static or pulse)
092	K4 (static or pulse)
093	Hysteresis K1
094	Hysteresis K2
095	Hysteresis K3
096	Hysteresis K4
097	Preselection mode K1
098	Preselection mode K2
099	Preselection mode K3
100	Preselection mode K4
101	Preset mode
102	Output polarity
103	n.a.
104	n.a.
105	Start-up Inhibit for Outputs
106	Calculation of trailing preselections

F11	Mode of Linearisation
F11.108	Linearisation mode counter 1
F11.109	Linearisation mode counter 2

F12	Table of Linearisation Counter 1
F12.114	First interpolation point (x1 value)
F12.115	First interpolation point (y1 value)
etc. ----->	
F12.144	Last interpolation point (x16 value)
F12.145	Last interpolation point (y16 value)

F13	Table of Linearisation Counter 2
F13.146	First interpolation point (x1 value)
F13.147	First interpolation point (y1 value)
etc. ----->	
F13.176	Last interpolation point (x16 value)
F13.177	Last interpolation point (y16 value)

The following schematics shows how in principle the parameter blocks are assigned to the various elements and functions of the counter.

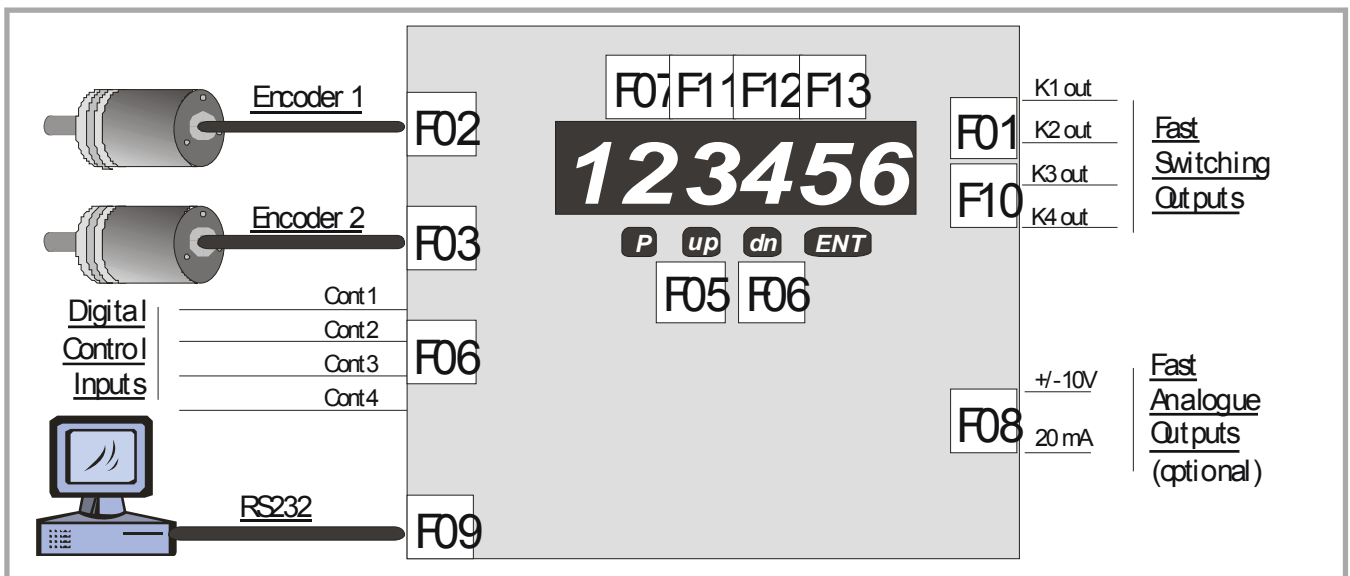

Where you find **highlighted indications** in the following parameter listings, this indicates that the setting range depends on the model and is 6 digits with 6 decade models and 8 digits with 8 decade models

5.2. Description of the Parameters

5.2.1. Preselections and presets

F01		Range	Default
F01.000	Preselection K1	-199 999 ... 999 999	1 000
F01.001	Preselection K2	-199 999 ... 999 999	2 000
F01.002	Preselection K3	-199 999 ... 999 999	3 000
F01.003	Preselection K4	-199 999 ... 999 999	4 000
F01.004	Preset value encoder 1	-199 999 ... 999 999	000 000
	Upon internal or external command the encoder 1 counter will set to this value		
F01.005	Preset value encoder 2	-199 999 ... 999 999	000 000
	Upon internal or external command the encoder 2 counter will set to this value		

5.2.2. Definitions for encoder 1

F02		Range	Default
F02.010	Encoder properties	0 ... 3	1
	0= Differential signals A, /A, B, /B (2 x 90°) *)		
	1= HTL signals A, B (2 x 90°) single-ended		
	2= Differential signals A, /A for count *) Differential signals B, /B to indicate static direction (if available)		
	3= HTL signal A (single-ended) for count HTL signal B (single-ended) to indicate static direction (if available)		
F02.011	Edge counting	0 ... 2	0
	0= Simple (x1)		
	1= Double (x2)		
	2= Full quadrature (x4)		
F02.012	Counting direction	0 ... 1	0
	0= Up when A leads B		
	1= Down when A leads B		
F02.013	Impulse scaling factor	0.00001 ... 9.99999	1.00000
	Multiplier for input impulses		
F02.014	Impulse multiplier	001 ... 999	001
	Multiple count of every impulse		
F02.015	Round-loop cycle	0 ... 999 999	0
	0= Unlimited counting range		
	xxx Round-loop operation in a range 0 - xxx		

*) Applies for any kind of differential signals, no matter if RS422 or TTL level or HTL level

Definitions for encoder 2

F03		Range	Default
F03.018	Encoder properties	0 ... 3	1
	0= Differential signals A, /A, B, /B (2 x 90° *) 1= HTL signals A, B (2 x 90°) single-ended 2= Differential signals A, /A for count *) Differential signals B, /B to indicate static direction (if available) 3= HTL signal A (single-ended) for count HTL signal B (single-ended) to indicate static direction (if available)		
F03.019	Edge counting	0 ... 2	0
	0= Simple (x1) 1= Double (x2) 2= Full quadrature (x4)		
F03.020	Counting direction	0 ... 1	0
	0= Up when A leads B 1= Down when A leads B		
F03.021	Impulse scaling factor	0.00001 ... 9.99999	1.00000
	Multiplier for input impulses		
F03.022	Impulse multiplier	001 ... 999	001
	Multiple count of every impulse		
F03.023	Round-loop cycle	0 ... 999 999	0
	0= Unlimited counting range xxx Round-loop operation in a range 0 - xxx		

*) Applies for any kind of differential signals, no matter if RS422 or TTL level or HTL level

5.2.3. Special functions

F04		Range	Default
F04.026	Digital input filter	0 ... 3	0
F04.027	Power-down memory	0 - 1	0
	0= Off. Counter resets to zero after power down 1= On. Counter stores last counting result		
F04.028	Trigger threshold for encoder1 inputs (**)	30 ... 250	166
F04.029	Trigger threshold for encoder2 inputs (**)	30 ... 250	166
F04.030	Multi-purpose parameter, function depending on application as shown under 4.1, 4.9, 4.10, 6.3	0 ... 999	0
F04.031	Multi-purpose parameter, function depending on application as shown under 4.9, 4.10	0 ... 999	0

**) Must be set to the default value (166) with any kind of input signals, except if exceptionally single-ended TTL signals should be used. Only in this case setting 35 is required.

5.2.4. Keypad protection codes

F05	Range	Default
F05.033 Protected group F01	0 = no protection 1 - 999 999 = Protection code for the actual group	0
F05.034 Protected group F02		
F05.035 Protected group F03		
F05.036 Protected group F04		
F05.037 Protected group F05		
F05.038 Protected group F06		
F05.039 Protected group F07		
F05.040 Protected group F08		
F05.041 Protected group F09		
F05.042 Protected group F10		
F05.043 Protected group F11		
F05.044 Protected group F12		
F05.045 Protected group F13		

5.2.5. Key commands and control input definitions

F06	Range	Default
F06.050 Function assignment to key „UP“ 0= No function 1= Reset counter 1 (encoder 1) (Clears also points of change of direction) 2= Reset counter 2 (encoder 2) 3= Reset counter 1 and counter 2 4= Set counter 1 to Set Value 1 *) 5= Set counter 2 to Set Value 2 *) 6= Set both counters to Set Value *) 7= Inhibit counter 1 8= Inhibit counter 2 9= n.a. 10= Start serial transmission 11= Reset minimum/maximum records 12= Scroll actual display 13= Special command (depends on counter mode) 14= n.a.	0 ... 14	0
F06.051 Function assignment to key „DOWN“ See key „UP“	0 ... 14	0
F06.052 Function assignment to key „ENTER“ See key „UP“	0 ... 14	0

*) Parameter F10.101 defines the source of the Set Value (see 6.3)

F06	(continued)	Range	Default
F06.053	Switching characteristics of input „Cont.1“ 0= NPN (switch to -) function active LOW 1= NPN (switch to -) function active HIGH 2= NPN (switch to -) rising edge 3= NPN (switch to -) falling edge 4= PNP (switch to +), function active LOW 5= PNP (switch to +), function active HIGH 6= PNP (switch to +), rising edge 7= PNP (switch to +), falling edge	0 ... 7	0
F06.054	Function assignment to input „Cont.1“ 0= No function 1= Reset counter 1 (encoder 1) (Clears also points of change of direction) 2= Reset counter 2 (encoder 2) 3= Reset counter 1 and counter 2 4= Set counter 1 to Set Value 1 *) 5= Set counter 2 to Set Value 2 *) 6= Set both counters to Set Value *) 7= Inhibit counter 1 and read **) 8= Inhibit counter 2 and read **) 9= n.a. 10= Start serial transmission 11= Reset minimum/maximum records 12= Scroll actual display 13= Special command (depends on counter mode) 14= Hardware keypad interlock	0 ... 14	0
F06.055	Switching characteristics of input „Cont.2“ See „Cont.1“ (F06.053)	0 ... 7	0
F06.056	Function assignment to input „Cont.2“ See „Cont.1“ (F06.054)	0 ... 14	0
F06.057	Switching characteristics of input „Cont.3“ See „Cont.1“ (F06.053)	0 ... 7	0
F06.058	Function assignment to input „Cont.3“ See „Cont.1“ (F06.054)	0 ... 14	0
F06.059	Switching characteristics of input „Cont.4“ See „Cont.1“ (F06.053), however this input does not support edge-triggered function	0, 1, 4, 5	0
F06.060	Function assignment to input „Cont.4“ See „Cont.1“ (F06.054)	0 ... 14	0
 <p>Unconnected NPN inputs are always HIGH (internal pull-up resistor) Unconnected PNP inputs are always LOW (internal pull-down resistor) *) Parameter F10.101 defines the source of the Set Value (see 6.3)</p>			

5.2.6. Basic settings

F07		Range	Default
F07.062	Operation mode of the counter	0 ... 10	0
	0= „Single“, encoder 1 only 1= „Sum“, encoder 1 + encoder 2 2= „Differential“, encoder 1 – encoder 2 3= Master counter and batch counter 4= Measuring of real cutting length 5= Calculation of roll diameters 6= Calculation of roll radius 7= n.a. 8= n.a. 9= Slip-, torsion- skew position monitor 10= Dual counter, independent counters 1 and 2		
F07.063	Decimal point position of encoder 1	0 ... 5	0
F07.064	Decimal point position of encoder 2	0 ... 5	0
F07.065	Decimal point position combined <1&2>	0 ... 5	0
F07.066	Scaling factor for combined values <1&2>	0.0001 – 9.9999	1.0000
F07.067	Divider for combined values*	0.0000 – 9.9999	0
F07.068	Offset value for combined values	-199 999 ... 999 999	0
F07.069	Brightness of the 7-segment LED display	0 ... 4	0
	0= 100% of maximum brightness 1= 80% of maximum brightness 2= 60% of maximum brightness 3= 40% of maximum brightness 4= 20% of maximum brightness		

*) Setting 0,0000 will skip the whole recalculation and speed up the cycle time

5.2.7. Serial communication parameters

F09		Range	Default
F09.081	Serial device address (unit number)	11 ... 99	11
F09.082	Serial baud rate	0 ... 6	0
	0= 9600 Baud		
	1= 4800 Baud		
	2= 2400 Baud		
	3= 1200 Baud		
	4= 600 Baud		
	5= 19200 Baud		
	6= 38400 Baud		
F09.083	Serial data format	0 ... 9	0
	0= 7 Data, Parity even, 1 Stop		
	1= 7 Data, Parity even, 2 Stop		
	2= 7 Data, Parity odd, 1 Stop		
	3= 7 Data, Parity odd, 2 Stop		
	4= 7 Data, no Parity, 1 Stop		
	5= 7 Data, no Parity, 2 Stop		
	6= 8 Data, Parity even, 1 Stop		
	7= 8 Data, Parity odd, 1 Stop		
	8= 8 Data, no Parity, 1 Stop		
	9= 8 Data, no Parity, 2 Stop		
F09.084	Serial protocol select *)	0 ... 1	0
	0= Transmission = Unit Nr. - Data, LF, CR		
	1= Transmission = Data, LF, CR		
F09.085	Serial timer (sec.) for timer transmissions *)	0.000 ... 99.999	0
F09.086	Serial register code of the transmit parameter *)	0 ... 19	14

*) for more details please see appendix in section 10

5.2.8. Switching characteristics and presets

F10		Range	Default
F10.089	Pulse time (sec.) output K1 (0 = static output)	0.00 ... 9.99	0.00
F10.090	Pulse time (sec.) output K2 (0 = static output)		
F10.091	Pulse time (sec.) output K3 (0 = static output)		
F10.092	Pulse time (sec.) output K4 (0 = static output)		
F10.093	Switching hysteresis K1 (display units) *)	0 ... 9999	0
F10.094	Switching hysteresis K2 (display units) *)		
F10.095	Switching hysteresis K3 (display units) *)		
F10.096	Switching hysteresis K4 (display units) *)		

*) The switching point equals to the preset value and the return point is displaced by the hysteresis setting

F10		Range	Default
F10.097	Switching characteristics K1 0= active with display \geq preselection 1= active with display \leq preselection 2= active with display \geq preselection, 0→counter. Remaining errors are cancelled 3= active with display \leq preselection, Set→counter. Remaining errors are cancelled 4= active with display \geq preselection, 0→counter Remaining errors added to following cycle 5= active with display \leq preselection, Set→counter Remaining errors added to following cycle	0 ... 5	0
F10.098	Switching characteristics K2 (see K1, F10.097)	0 ... 5	0
F10.099	Switching characteristics K3 (see K1, F10.097)		
F10.100	Switching characteristics K4 (see K1, F10.097)		
F10.101	Set value of the counter 0= Set value = Preset (1 or. 2) 1= Set value = Preselection K1 or K2	0 ... 1	0
F10.102	K1 - K4 outputs N.C or N.O *) K1= binary value 1 K2= binary value 2 K3= binary value 4 K4= binary value 8 Bit = 0: Output switches ON when active (N.O.) *) Bit = 1: Output switches OFF when active (N.C.) *)	0 ... 15	0
F10.103	n.a.		0
F10.104	n.a.		0
F10.105	Start-up Inhibit of timed K1-K4 outputs after power-up	0 = pulses enabled 1 = pulses disabled	0
F10,106	Switch point calculation with trailing preselections 0: K1=>K1, K2=>K2, K3=>K3, K4=>K4 1: K1=>K1, <u>K1-K2=>K2</u> , K3=>K3, K4=>K4 2: K1=>K1, K2=>K2, K3=>K3, <u>K3-K4=>K4</u> 3: K1=>K1, <u>K1-K2=>K2</u> , K3=>K3, <u>K3-K4=>K4</u> Example: if set to "1" the K2 switching point would be substituted by the difference K1 - K2 (i.e. F00.000 - F00.001)	0 ... 3	0



*) **N.O.** means "normally open", saying that the corresponding output is normally switched OFF and will switch on when the assigned event happens.

*) **N.C.** means "normally closed", saying that the corresponding output is normally switched ON and will switch off when the assigned event happens

5.2.9. Parameters for Linearisation

F11	Modes of Linearisation	Range	Default
F11.108	Mode of linearization for counter 1 (encoder 1) 0 = Linearisation off 1 = Linearisation is defined for the numeric range from 0 to +999 999 only and negative values will appear as a mirror of the positive values 2 = Linearisation is defined over the full range from - 199 999 to +999 999	0 - 2 (see drawings on next page)	0
F11.109	Mode of linearization for counter 2 (encoder 2) 0 = Linearisation off 1 = Linearisation is defined for the numeric range from 0 to +999 999 only and negative values will appear as a mirror of the positive values 2 = Linearisation is defined over the full range from - 199 999 to +999 999	0 - 2 (see drawings on next page)	0

F12	Table of linearization for counter 1 (encoder 1)	Range	Default
F12.114	First interpolation point, (x0, original value)	-199 999 to 999 999	0
F12.115	First interpolation point, (y0, replacement value)		
F12.116	Second interpolation point (x1, original value)		
F12.117	Second interpolation point (y1, replacement value)		
	etc. ---->		
F12.144	Last interpolation point, (x15, original value)		
F12.145	First interpolation point, (y15, replacement value)		

F13	Table of linearization for counter 2 (encoder 2)	Range	Default
F13.146	First interpolation point, (x0, original value)	-199 999 to 999 999	0
F13.147	First interpolation point, (y0, replacement value)		
F13.148	Second interpolation point (x1, original value)		
F13.149	Second interpolation point (y1, replacement value)		
	etc. ---->		
F13.176	Last interpolation point, (x15, original value)		
F13.177	Last interpolation point, (y15, replacement value)		

5.2.10. Hints for using the linearization function

The subsequent drawing explains the difference between the modes of linearization.

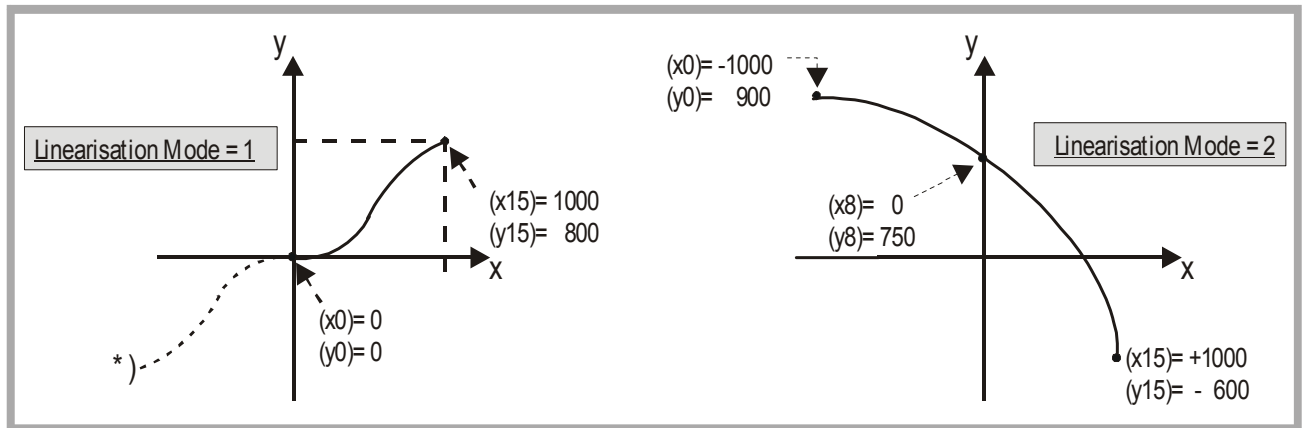

- x-registers are to set the numeric counter value that the unit would display without linearization
- y-registers are to set the numeric value that should be displayed instead (i.e. the y3 setting will replace the display value x3)
- between the interpolation points the unit automatically uses linear interpolation
- x-registers have to use continuously increasing values, e.g. the lowest display value must be set to register x0, and the highest display value must be set to x16
- Independent of the selected linearization mode, the possible setting range of all registers x0, y0, ... x16, y16 is always -199999 ... 999999.
- For measuring values outside of the defined linearization range, please note: If the measuring value is lower than x0, the linearization result will always be y0. If the measuring value is higher than x16, the linearization result will always be y16.

5.3. Clarification of the Counter Setting Functions

This section is only important if you intend to preset the counter to values different from zero. The menu provides several options to reset one or both of counters to zero, or to set the counters to programmable preset values.

Whilst with a reset command the data loaded into the counter is always zero, the setting procedure may load data from different locations, depending on the operating mode and some parameter settings.

The tables below are to clarify which source the counters are using under which conditions. It would not make any sense to use the preset functions with other counter modes than those shown below, therefore the tables indicate the reasonable possibilities only.

The triggering event to activate a preset action depends on your parameter settings and can be manual (front key or control input) or automatic (when the counter reaches one of the four preselection thresholds K1 to K4).

The source of the loading data can be one of the two counter preset values set to parameters F01.004 and F01.005, or any of the four preselection thresholds K1 to K4 adjusted by keypad or by front thumbwheel switches.

The target for loading data can be either counter1 or counter2

The following abbreviations are used:

P1 = Preset value encoder 1 (F01.004)	P2 = Preset value encoder 2 (F01.005)
C1 = Counter 1	C2 = Counter 2
K1 ... K4 = Preselections (F01.000 to F01.003) or thumbwheels	Man. = remote set command (key or input) K1auto etc. = automatic set command triggered by K1

Single mode	Parameter F10.101 = 0					Parameter F10.101 = 1				
	Man.	K1auto	K2auto	K3auto	K4auto	Man.	K1auto	K2auto	K3auto	K4auto
Counter1:	P1→C1	P1→C1	P1→C1	P2→C1	P2→C1	K1→C1	K1→C1	K2→C1	K3→C1	K4→C1

Sum mode (F07.062 = 1)	Parameter F10.101 = 0					Parameter F10.101 = 1				
	Man.	K1auto	K2auto	K3auto	K4auto	Man.	K1auto	K2auto	K3auto	K4auto
Counter 1:	P1→C1	P1→C1	P1→C1	P1→C1	P1→C1	K1→C1	K1→C1	K2→C1	K1→C1	K2→C1
Counter 2:	P2→C2	---	---	P2→C2	P2→C2	K3→C2	---	---	K3→C2	K4→C2

Diff. mode (F07.062 = 2)	Parameter F10.101 = 0					Parameter F10.101 = 1				
	Man.	K1auto	K2auto	K3auto	K4auto	Man.	K1auto	K2auto	K3auto	K4auto
Counter 1:	P1→C1	P1→C1	P1→C1	P1→C1	P1→C1	K1→C1	K1→C1	K2→C1	K1→C1	K2→C1
Counter 2:	P2→C2	---	---	P2→C2	P2→C2	K3→C2	---	---	K3→C2	K4→C2

Batch mode (F07.062 = 3)	Parameter F10.101 = 0					Parameter F10.101 = 1					
	Trigger event	Man.	K1auto	K2auto	K3auto	K4auto	Man.	K1auto	K2auto	K3auto	K4auto
Counter 1:	P1→C1	P1→C1	P1→C1	P1→C1	P1→C1	P1→C1	K1→C1	K1→C1	K2→C1	*→C1	*→C1
Counter 2:	P2→C2	---	---	P2→C2	P2→C2	P2→C2	K3→C2	---	---	K3→C2	K4→C2

*) no change if multi-purpose parameter F04.030 = 0, otherwise C1 cleared to zero

6. Specifications

AC power supply	:	24 V~ +/- 10%, 15 VA
DC power supply	:	24V- (17 - 40V), approx. 100 mA (+ encoders)
Aux. encoder supply outputs:		2 x 5,2 VDC, 150 mA each 2 x 24V DC, 120 mA each (not with 1st series)
Inputs	:	2 universal encoder inputs (Ri = 8.5 kΩ each channel) 4 digital control inputs HTL (Ri = 3.3 kΩ) Low < 2.5 V, High > 10 V, min. pulse width 50 μsec.
Counting frequency (per encoder)	:	RS422 and TTL differential: 1 MHz HTL single ended: 200 kHz TTL single-ended: 200 kHz
Switching outputs	:	4 fast power transistors 5 - 30V, 350 mA (b) Response time < 1 msec. (a),
Serial link	:	RS232, 2400 - 38400 Bauds
Ambient temperature	:	Operation: 0 - 45°C (32 - 113°F) Storage: -25 - +70°C (-13 - 158°F)
Housing	:	Norly UL94 - V-0
Display	:	6 Digit, high-efficiency red, 14.22 mm (0.56' ') or 8 digit, high-efficiency red 9.15 mm (0.36' ')
Protection class (front side only)	:	IP65
Protection class rear side	:	IP20
Screw terminals	:	Cross section max. 1.5 mm ² ,
Conformity and standards:		EMC 2004/108/EC: EN 61000-6-2 EN 61000-6-3 LV 2006/95/EC: EN 61010-1

(a) Continuous serial communication may temporary increase response times

(b) Diode or RC filtering is mandatory when switching inductive loads

7. Dimensions

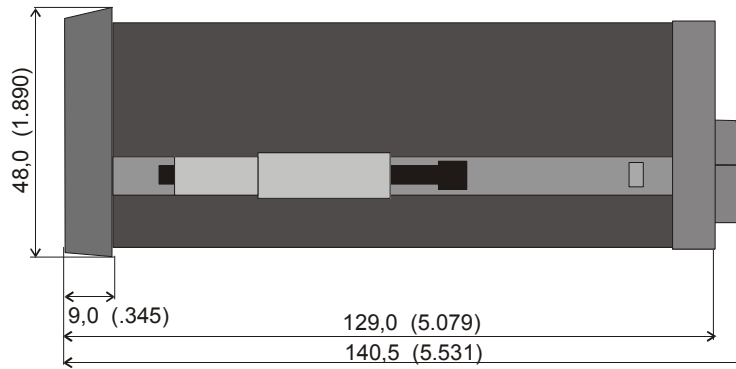
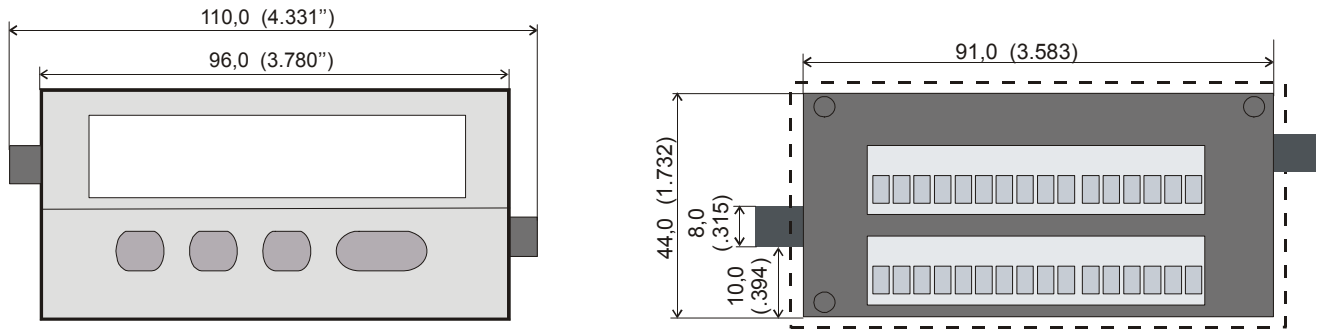

Panel cut out: 91 x 44 mm (3.583 x 1.732")

8. Appendix: Serial Communication Details

Serial communication with the counter can be used for the following purposes:

- PC setup of the counter, using the OS32 Operator software
- Automatic and cyclic transmission of counter data to remote devices like PC, PLC or Data Logger
- Communication via PC or PLC, using the communication protocol

This section describes the essential and basic communication features only. Full details are available from the special SERPRO manual.

8.1. Setup of the Counter by PC

Connect the counter to your PC as shown in section 3.6 of this manual. Start the OS32 Operator software. After a short initializing time you will see the following screen:

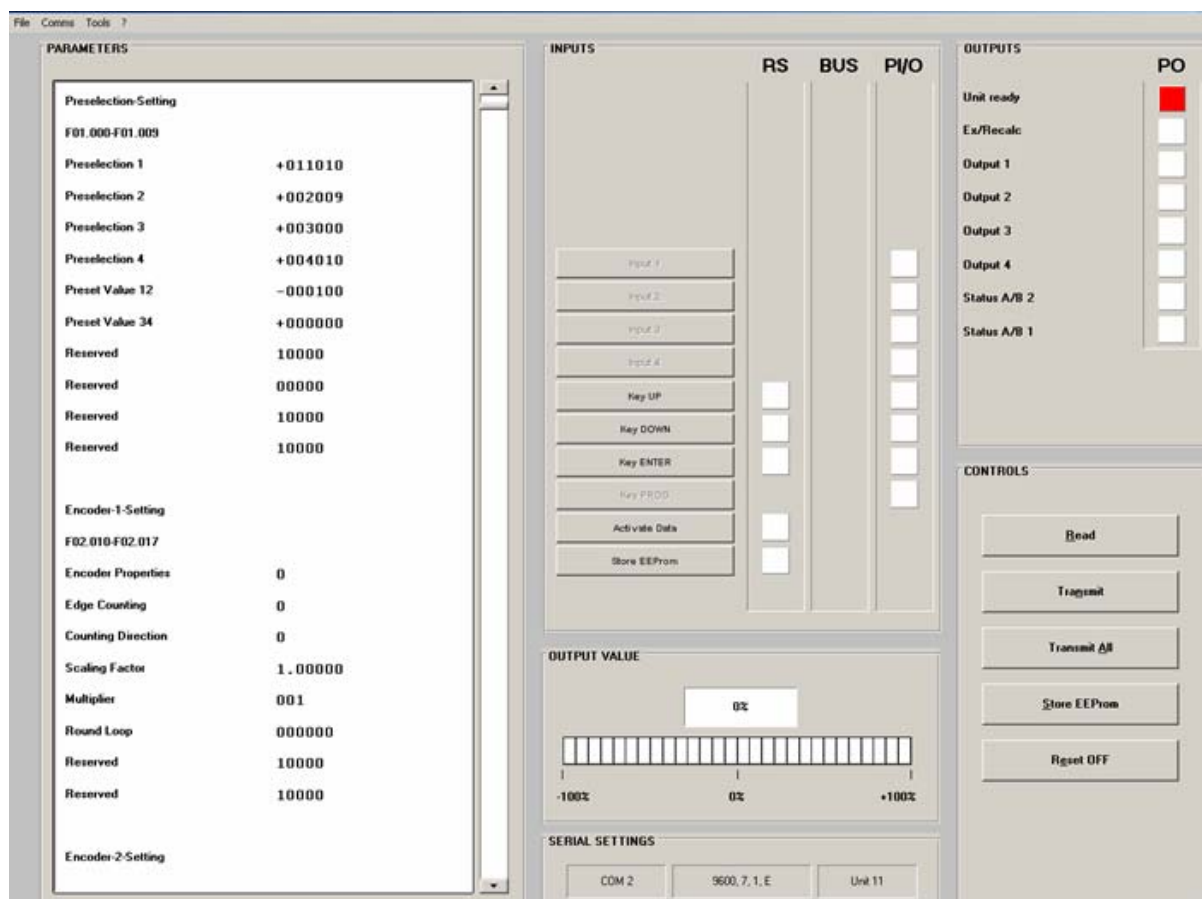

If your screen remains empty and the headline of your PC says „OFFLINE“, select „Comms“ of the menu bar and check your serial communication settings.

The edit field on the left shows all actual parameters and provides full editing function. The „File“ menu allows to store complete sets of parameters for printout or for download to a counter.

When editing parameters, please use the ENTER key of your PC after each entry, to ensure storage of your data to the counter.

8.2. Automatic and Cyclic Data Transmission

Set any cycle time unequal to zero to parameter F09.085.

Set the serial access code of the register you would like to transmit to parameter F09.086. In theory you could transmit any of the internal registers by serial link, however only the following registers make really sense:

F09.086 = 6 :	Actual count value of counter 1 (encoder 1)
F09.086 = 7 :	Actual count value of counter 2 (encoder 2)
F09.086 = 8 :	Actual analogue output voltage (models xxx.E95)
F09.086 = 9 :	Latest minimum value from the minimum record register
F09.086 = 10 :	Latest maximum value from the maximum record register
F09.086 = 14 :	Actual display value as shown on the LED display

Dependent on the setting of parameter F09.084 the unit transmits one of the following data strings, under cycle control of the timer:

(xxxx = counter data*, LF = Line Feed <hex. 0A>, CR = Carriage Return <hex 0D>)

*) Leading zeros will not be transmitted

	(Unit No.)											
F09.084 = 0 :	1	1	+/-	X	X	X	X	X	X	X	LF	CR
F09.084 = 1 :			+/-	X	X	X	X	X	X	X	LF	CR

8.3. Communication Protocol

When communicating with the unit via protocol, you have full read/write access to all internal parameters, states and actual counter values. The protocol uses the DRIVECOM standard according to DIN ISO 1745. A list with the most frequently used serial access codes can be found in the subsequent section.

To request data from the counter, the following request string must be sent:

EOT	AD1	AD2	C1	C2	ENQ
EOT = Control character (Hex 04)					
AD1 = Unit address, High Byte					
AD2 = Unit address, Low Byte					
C1 = Register code to read, High Byte					
C2 = Register code to read, Low Byte					
ENQ = Control character (Hex 05)					

The example shows how to request for transmission of the actual count of counter 1 (register code :6), from a unit with unit address 11:

ASCII-Code:	EOT	1	1	:	6	ENQ
Hexadecimal:	04	31	31	3A	36	05
Binary:	0000 0100	0011 0001	0011 0001	0011 1010	0011 0110	0000 0101

Upon correct request, the counter will respond:

STX	C1	C2	xxxxxxx	ETX	BCC
STX = Control character (Hex 02) C1 = Register code to read, High Byte C2 = Register code to read, Low Byte xxxxx = Counter data *) ETX = Control character (Hex 03) BCC = Block check character					

*) Leading zeros will not be transmitted

The Block-Check-Character represents the EXCLUSIVE-OR function of all characters from C1 to ETX (both comprised).

To write to a parameter, you have to send the following string:

EOT	AD1	AD2	STX	C1	C2	xxxxxxx	ETX	BCC
EOT = Control character (Hex 04) AD1 = Unit address, High Byte AD2 = Unit address, Low Byte STX = Control character (Hex 02) C1 = Register code to write, High Byte C2 = Register code to write, Low Byte xxxxx = Value of the parameter ETX = Control character (Hex 03) BCC = Block check character								

Upon correct receipt the unit will respond by ACK, otherwise by NAK.

Every new parameter sent will first go to a buffer memory, without affecting the actual counting process. This function enables the user, during normal counting operation, to prepare a complete new parameter set in the background.

To activate transmitted parameters, you must write the numeric value “1” to the “Activate Data” register. This immediately activates all changed settings at the same time.

Where you like the new parameters to remain valid also after the next power up of the unit, you still have to write the numeric value “1” to the „Store EEPROM“ register. This will store all new data to the EEPROM of the counter. Otherwise, after power down the unit would return with the previous parameter set.

8.4. Serial Register Codes

8.4.1. Communication Commands

Function	Code
Activate Data	67
Store EEPROM	68

These commands have to be sent to the unit every time after one or several new parameters have been transmitted, in order to activate or to store the new values. Both commands are "dynamic", i.e. it is sufficient to just send the data value "1" to the corresponding code position.

Example: send the command "Activate Date" to the counter with Unit No. 11:

ASCII	EOT	1	1	STX	6	7	1	ETX	BCC
Hex	04	31	31	02	36	37	31	03	33

8.4.2. Control Commands

To activate control commands (e.g. Reset) by serial link, the following steps are required:

- the desired command has first to be assigned to one of the front keys or control inputs (any), as described in chapter 6.2.6.
- after this the corresponding key or input can be virtually activated by serial command (same as if you would push the key or activate the hardware input). This kind of command provides static operation. Sending "1" to the corresponding location will switch the command ON, it will remain on until you send "0" to the same location to switch the command OFF again.

Control Input / Front Key	Code
Input "Cont1"	59
Input "Cont2"	60
Input "Cont3"	61
Input "Cont4"	62
Key "UP"	63
Key "DN"	64
Key "Enter"	65

Example: Parameter F06.054 = 1, i.e. input "Cont1" has been configured for "Reset Counter1"
(see 6.2.6).

Switch the Reset ON (unit number 11):

ASCII	EOT	1	1	STX	5	9	1	ETX	BCC
Hex	04	31	31	02	35	39	31	03	3E

Switch the Reset OFF again (unit number 11):

ASCII	EOT	1	1	STX	5	9	0	ETX	BCC
Hex	04	31	31	02	35	39	30	03	3F



Function code "10" (Start Serial Transmission) is **incompatible** with the serial handling of control commands and will cause communication conflicts

8.4.3. Counter parameters

No.	Menu	Name	Code	Min	Max	Default
0	<u>Preselection-Setting</u>	Preselection 1	00	- 199999	999999	1000
1		Preselection 2	01	- 199999	999999	2000
2		Preselection 3	02	- 199999	999999	3000
3		Preselection 4	03	- 199999	999999	4000
4		Preset Value 12	04	- 199999	999999	0
5		Preset Value 34	05	- 199999	999999	0

8.4.4. Linearisation parameters

No.	Menu	Name	Code	Min	Max	Default	
114	<u>Linearisation-Encoder-1</u>	P1(x)	J7	- 199999	999999	0	
115		P1(y)	J8	- 199999	999999	0	
116		P2(x)	J9	- 199999	999999	0	
117		P2(y)	K0	- 199999	999999	0	
..		
..		
142		P15(x)	M5	- 199999	999999	0	
143		P15(y)	M6	- 199999	999999	0	
144		P16(x)	M7	- 199999	999999	0	
145		P16(y)	M8	- 199999	999999	0	
146		<u>Linearisation-Encoder-2</u>	P1(x)	M9	- 199999	999999	0
147			P1(y)	N0	- 199999	999999	0
148			P2(x)	N1	- 199999	999999	0
149			P2(y)	N2	- 199999	999999	0
..		
..		

174		P15(x)	P7	- 199999	999999	0
175		P15(y)	P8	- 199999	999999	0
176		P16(x)	P9	- 199999	999999	0
177		P16(y)	Q0	- 199999	999999	0

8.4.5. Actual counter data

Nr.	Name	Code
6	Actual count value of counter 1 (encoder 1)	:6
7	Actual count value of counter 2 (encoder 2)	:7
8	Actual analogue output voltage (models xxx.E95)	:8
9	Latest minimum value from the minimum record register	:9
10	Latest maximum value from the maximum record register	;0
14	Actual display value as shown on the LED display	;4